

GX-630D

STEREO TAPE DECK

OPERATOR'S MANUAL

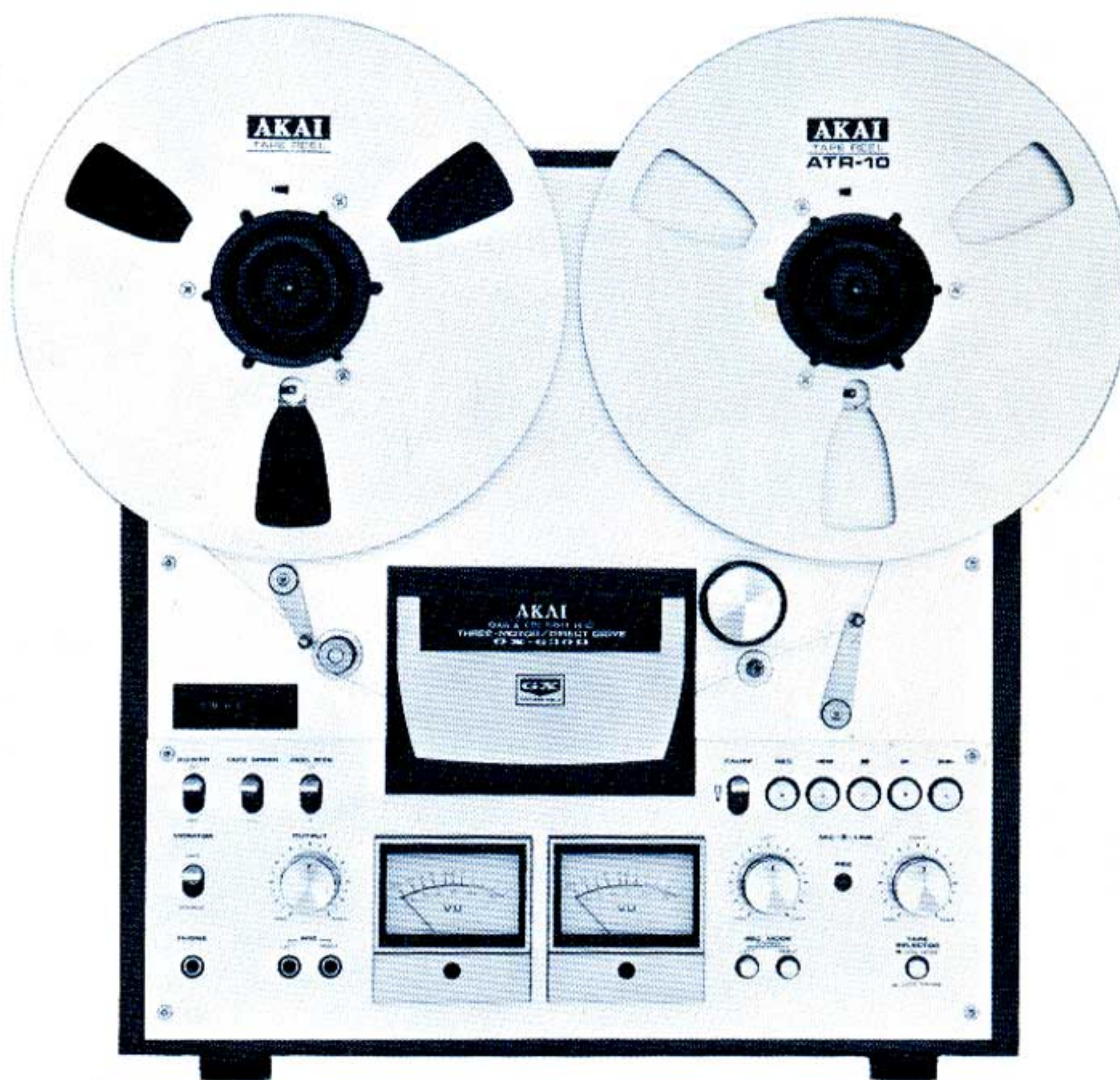

WARNING:

To prevent fire or shock hazard, do not expose this appliance to rain or moisture.

AKAI

MANUFACTURED & DISTRIBUTED BY AKAI ELECTRIC CO., LTD./AKAI TRADING CO., LTD./AKAI AMERICA LTD.

CEE, CSA, and UL Standard models are not equipped with a Voltage Selector and Cycle Change Switch. Therefore, voltage and cycle conversion is not necessary. If your machine corresponds to any of these standards, please disregard all references to voltage and cycle adjustment throughout this manual.

CEE Models: 220 V, 50 Hz.

CSA Models: 120 V, 60 Hz.

UL Models: 120 V, 60 Hz.

INDEX

Controls	2
Operating Precautions	4
4-Track Stereo Recording and Playback System	4
4-Track Monaural Recording and Playback System	4
Tape Loading	5
Tape Speed Selection	5
Sound Monitoring	6
Automatic Stop	6
Direct Function Change Control	6
Connections For Playback	7
Playback	8
Connections For Recording	9
Recording	10
Sound Mixing	11
Absentee Recording	11
Tape Erasing	11
Tape Splicing and Editing	11
Head Block Cleaning	12
Head Demagnetizing	12
Voltage and Cycle Conversion	13
Standard Accessories	14
Technical Data	14
Trouble Shooting Chart	15

CONTROLS

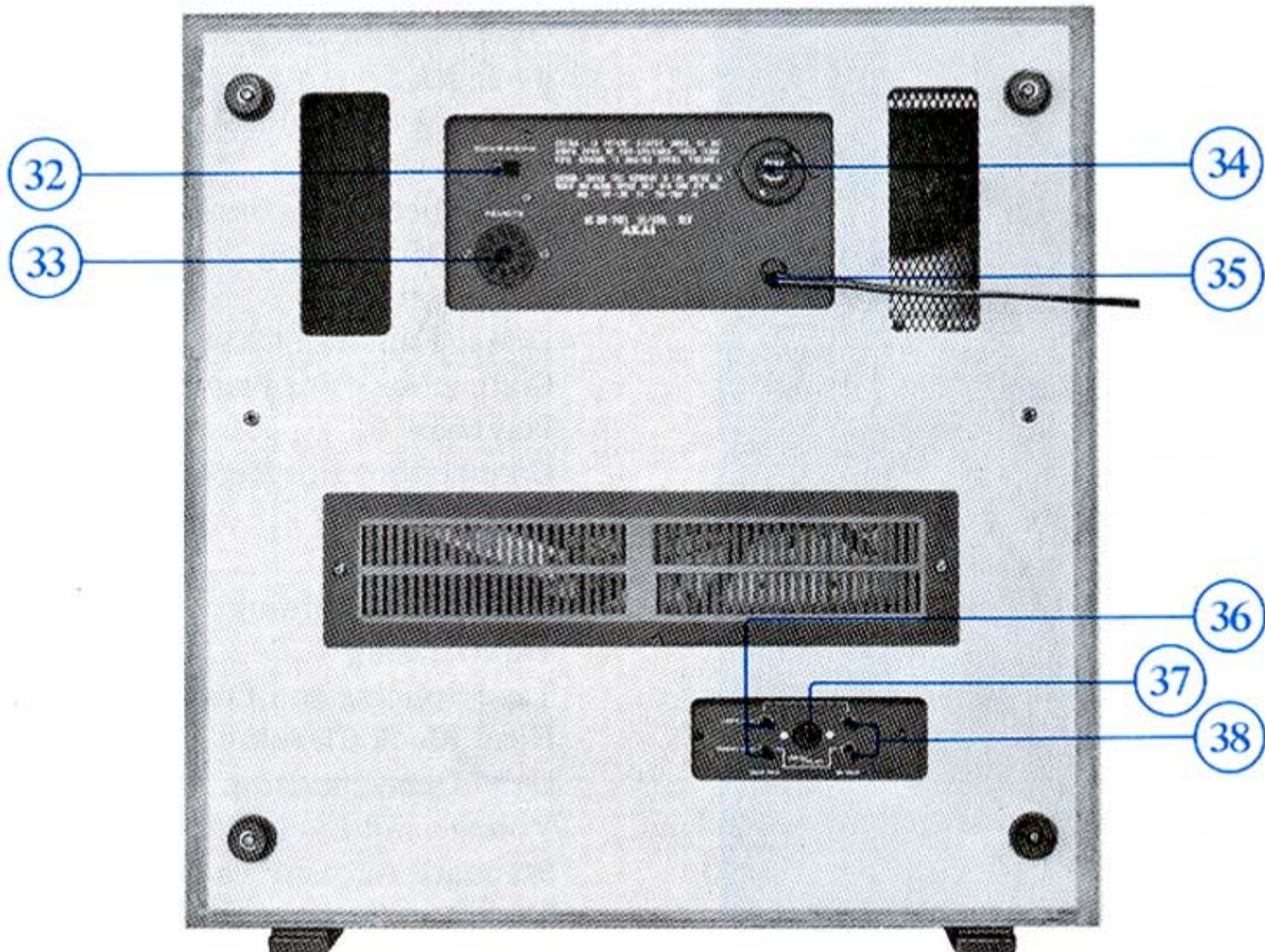
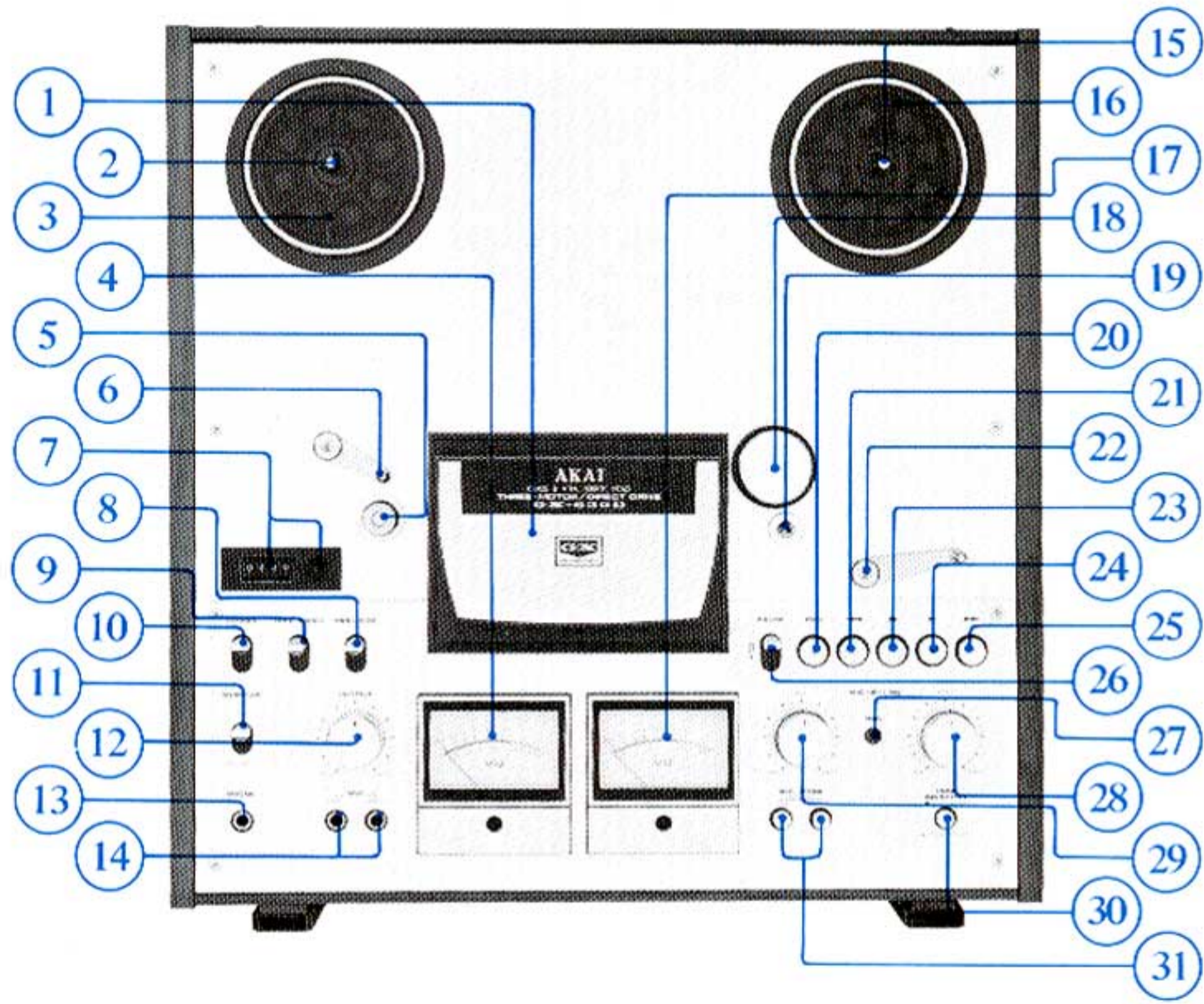

1. **HEAD COVER**
Houses head block including GX recording, GX playback, and erase heads.
2. **BUILT-IN REEL RETAINER (left)**
To lock reel firmly into place, pull tip of retainer outward and turn to left or right.
3. **SUPPLY REEL TABLE**
4. **VU METER (left)**
Indicates left channel recording and playback levels.
5. **IMPEDANCE ROLLER**
6. **TAPE TENSION LEVER**
Provides ideal tape tension.
7. **INDEX COUNTER AND RESET BUTTON**
8. **REEL SIZE SELECTOR**
Set to "10" when using 10-1/2" reels and to "7" when using 7" or 5" reels.
9. **TAPE SPEED SELECTOR**
Set to 7-1/2 or 3-3/4 ips according to desired speed.
10. **POWER SWITCH**
11. **TAPE MONITOR SWITCH**
Set to SOURCE position to monitor source and to TAPE position for playback or private headphone listening.
12. **OUTPUT LEVEL CONTROL**
Adjusts output level during playback. Set to correspond with amplifier input.
13. **HEADPHONE JACK**
Accommodates 8 ohms impedance type stereo headphones.
14. **MICROPHONE JACKS (left/right)**
15. **BUILT-IN REEL RETAINER**
To lock reel firmly into place, pull tip of retainer outward and turn to left or right.
16. **TAKE-UP REEL TABLE**
17. **VU METER (right)**
Indicates right channel recording and playback levels.
18. **PINCH WHEEL**
Presses against capstan to transport tape.
19. **CAPSTAN**
20. **RECORDING (REC) BUTTON**
Depress this Button and the Play ► Button simultaneously to effect recording mode.
* Caution: Be sure to depress the Track Selector Switch(es) prior to effecting recording mode.
21. **REWIND ◀◀ BUTTON**
Rewinds tape at high speed.
22. **AUTOMATIC STOP/TAPE TENSION LEVER**
23. **STOP ■ BUTTON**
24. **PLAY ► BUTTON**
Advances tape for recording or playback mode.
25. **FAST FORWARD ▶▶ BUTTON**
Advances tape at high speed.
26. **PAUSE SWITCH**
Depress to temporarily suspend tape travel during recording or playback. Especially convenient for editing tape. Simply depress when a certain portion of the program is not desired.
* Pause Control does not function during Fast Forward or Rewind Mode.
27. **RECORDING INDICATOR LAMP**
Lights to confirm recording mode.
28. **MICROPHONE/LINE INPUT LEVEL CONTROLS (right)**
Larger outer control adjusts right line input and smaller center control right microphone input level.
Adjust while observing right VU Meter.
29. **MICROPHONE/LINE INPUT LEVEL CONTROLS (left)**
Larger outer control adjusts left line input and smaller center control left microphone input level. Adjust while observing left VU Meter.
30. **TAPE SELECTOR SWITCH**
WIDE RANGE (In): Set to this position when using Wide Range Tape.
LOW NOISE (Out): Set to this position when using Low Noise Tape.
* Akai LN-150-7 or Scotch #211 Low Noise Tape is considered standard for this machine. The use of regular tape is not recommended.
* Set Wide Range position only when using special wide range tape of a grade higher than low noise.
31. **RECORDING MODE SWITCHES (Left and Right Channel Track Selectors)**
Depress left or right selector for monaural recording on left or right channel. For stereo recording, depress both switches simultaneously.
* Caution: Be sure to select track(s) prior to effecting recording mode.
32. **CYCLE CHANGE SWITCH (CEE, CSA, UL and LA models not equipped with this facility)**
Set to 50 Hz or 60 Hz position according to area power source.
33. **REMOTE CONTROL JACK**
Remote control of all operating functions can be accomplished with optional accessory Remote Control Unit RC-17.
* Absentee recording can also be accomplished by using Remote Control unit RC-17 together with a timer. (See ABSENTEE RECORDING procedure).
34. **UNIVERSAL VOLTAGE SELECTOR (CEE, CSA, UL and LA models not equipped with this facility)**
For voltage and cycle change, refer to VOLTAGE AND CYCLE CONVERSION procedure.
35. **A.C. CORD**
36. **LINE OUTPUT JACKS (left/right)**
37. **DIN JACK**
A DIN Jack has been provided on this model facilitating connection with an amplifier through a single Din Cord. However, to prevent cross talk between DIN input and output during recording, the DIN output signal is cut. Therefore, monitoring through an amplifier cannot be accomplished. If monitoring during recording is desired, use the tape deck Headphone Jack.
38. **LINE INPUT JACKS (left/right)**

OPERATING PRECAUTIONS

- * Your machine requires constant voltage for optimum performance. If voltage and cycle change is necessary, refer to VOLTAGE AND CYCLE CONVERSION procedure.
- * As dirty or magnetized heads become the source of loss of sound, sound drop-out, distortion, and other recording and playback failures, the heads should be kept clean and demagnetized at all times.
- * Place machine on a flat level surface and operate in either a vertical or horizontal position.
- * Do not place anything on top of the unit which will obstruct the ventilator.
- * If the sound sources are so far away from the microphones that the input level controls must be turned to maximum, some hum or noise will inevitably be

recorded. A test recording is recommended before making a final recording.

- * Akai LN-150-7 or Scotch #211 Low Noise Tape is considered standard for this machine. The use of regular tape is not recommended.
- * Set to Wide Range position only when using special wide range tape of a grade higher than low noise tape.
- * As tapes which have not been used for a period of time may have become sticky, run tape once before using.
- * Always store tapes in a cool, dry place. Should there be a problem with your machine, write down the model and serial numbers and all pertinent data regarding warranty coverage as well as a clear description of the existing trouble and contact your nearest authorized Akai Service Station or the Service Department of Akai Company, Tokyo, Japan.

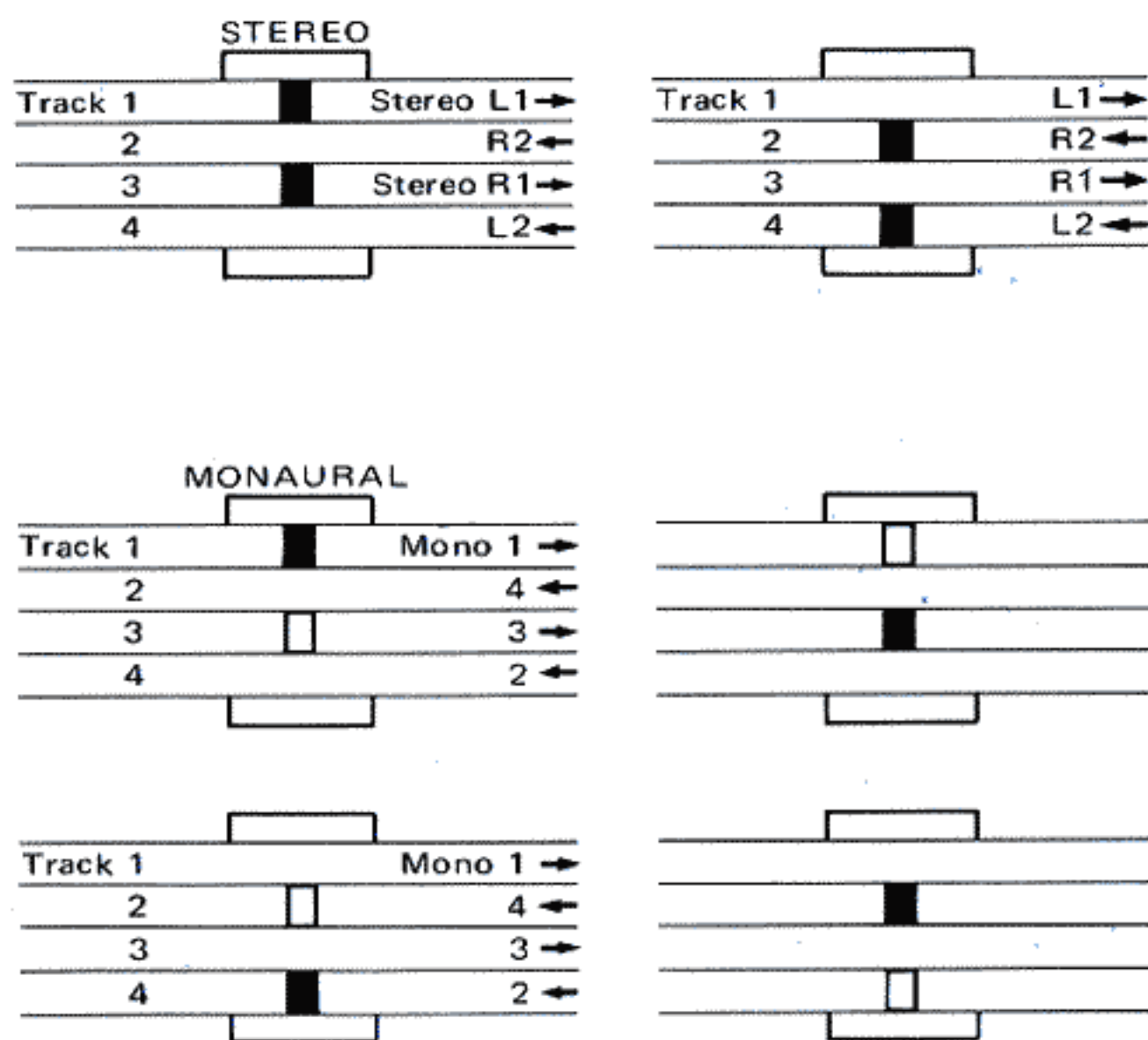

4-TRACK STEREO RECORDING AND PLAYBACK SYSTEM

Stereo recording requires the simultaneous use of two tracks. For stereo operation, depress both Recording Switches. The first stereo recording takes place on tracks 1 and 3, and the second on tracks 2 and 4 after the reels have been inverted.

The first stereo playback takes place on tracks 1 and 3, and the second on tracks 2 and 4 after the reels have been inverted.

4-TRACK MONAURAL RECORDING AND PLAYBACK SYSTEM

4-track monaural recording sequence is 1-4-3-2. For monaural operation, depress the left Recording Switch. The first recording takes place on track 1 and second on track 4 after the reels have been inverted.

For recording on Tracks 3 and 2, depress the right Recording Switch. The third recording takes place on track 3, and the fourth on track 2 after the reels have been inverted.

4-track monaural playback sequence is also 1-4-3-2, but if monaural recordings have been made on both the left and right channels of the tape, set the left or right output level control of the external amplifier to minimum at playback time so that only the desired channel is audible.

- * Do not depress the Recording Switches for playback.

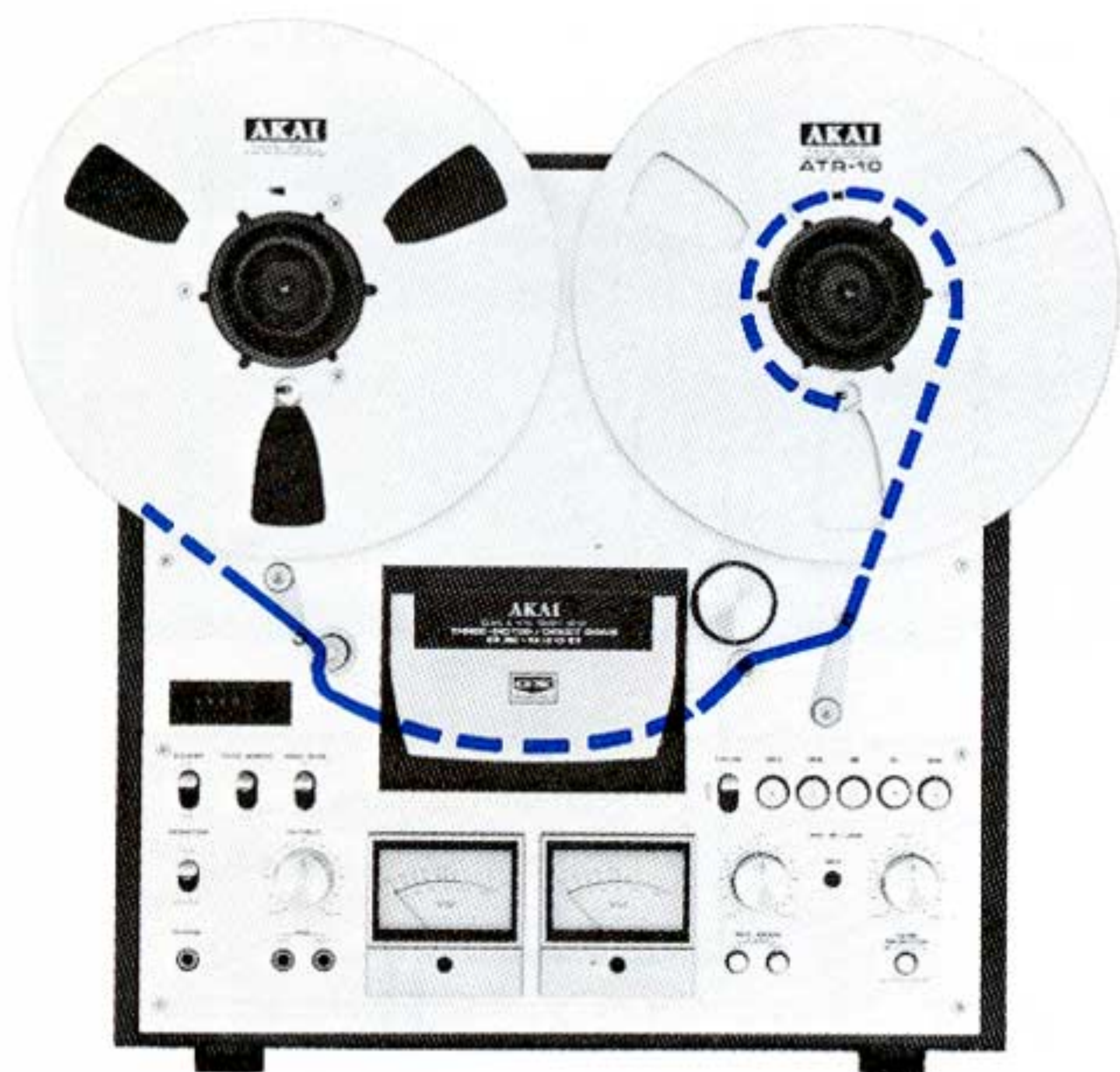

TAPE LOADING

1. Place a full reel of tape on the supply reel table and an empty reel on the take-up reel table.
2. Lock both reels into place by pulling tip of reel retainers outward and turning to left or right.
3. Unwind about an 85 cm length of tape from the supply reel and thread the tape as shown by the dotted lines in the figure.
4. Insert end of tape in slot of empty reel and wind around reel hub two or three times.
5. Continue winding tape onto take-up reel until all slack has been taken up.

When using 10½" reels, place the standard accessory reel adapter hubs on the left and right reel tables and lock into place by pulling tip of reel retainers outward and turning to left or right.

When using 10½" plastic reels

Fit hubs over reel tables so that the white lines on the inner and outer adapter hubs are aligned and match these lines with the dot on reel table.

When using 10½" metallic reels

Fit hubs over reel tables so that the white lines on the inner and outer adapter hubs are aligned, but do not match with dot on reel table. (This provides the necessary spacing for the difference in plastic and metal reel thickness).

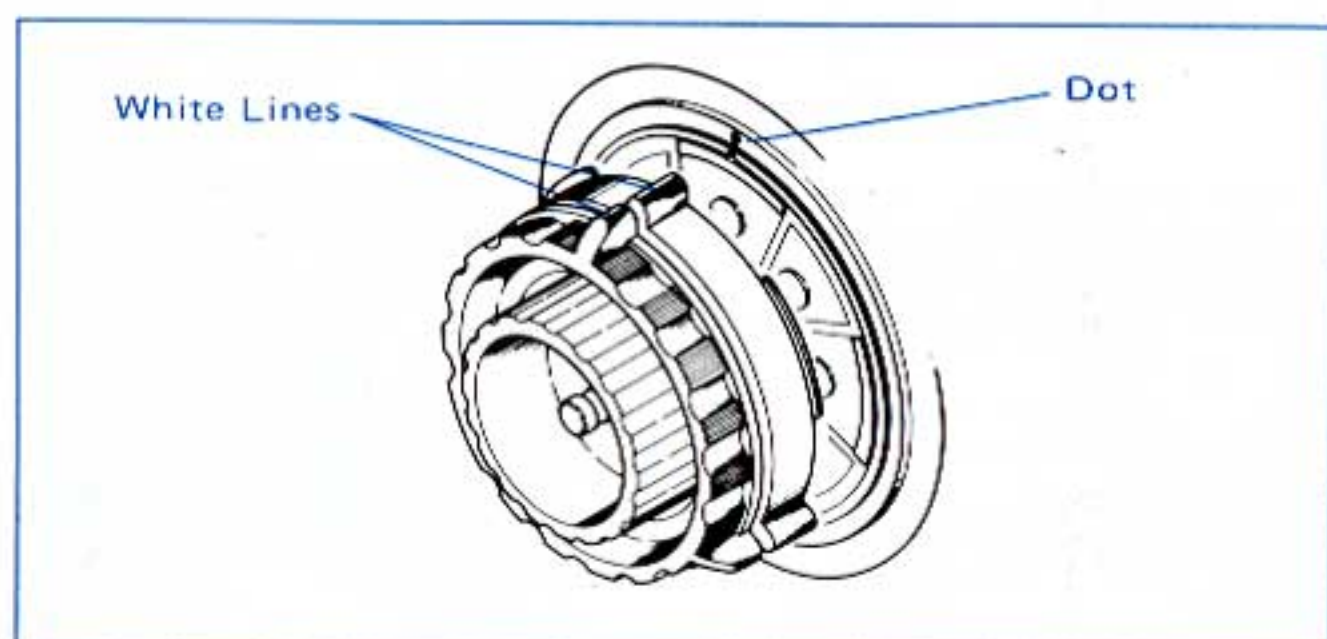

TAPE SPEED SELECTION

This model can be operated at 7½ ips or 3¾ ips tape speed. Stereo recording time using an 1800 ft. tape is 3 hours at 3¾ ips and 1.5 hours at 7½ ips. (6 hours at 3¾ ips and 3 hours at 7½ ips for monaural).

SOUND MONITORING

For private headphone listening, connect stereo headphones and set the Monitor Switch to TAPE position.

For more precise recording level adjustment, set Monitor Switch to SOURCE position and monitor signals through headphones while adjusting input level controls.

Dual monitoring for a more professional recording can also be accomplished by switching the Monitor Switch to and from TAPE and SOURCE to compare the just recorded signals with the input source.

- * Set Monitor Switch to TAPE position for playback through a speaker system.
- * Monaural headphone listening cannot be accomplished if different monaural recordings have been made on both the left and right channels of the tape (Signals from both channels are heard through headphones).
- * When using the DIN Jack, monitoring through an amplifier system during recording cannot be accomplished. (If monitoring during recording is desired when using the DIN Jack connection, utilize the Tape Deck Headphone jack).

AUTOMATIC STOP

At the end of the tape, the Automatic Stop/Tape Tension Lever drops, activating the automatic stop mechanism to stop reel movement. This automatic stop safety feature is especially convenient when the recorder is left unattended.

DIRECT FUNCTION CHANGE CONTROL

This model features feather-touch Full Direct Function Change Control. The necessity of depressing the Stop Button prior to changing modes is eliminated. The inclusion of direct function change to recording mode facilitates easy add-on recording.

CONNECTIONS FOR PLAYBACK

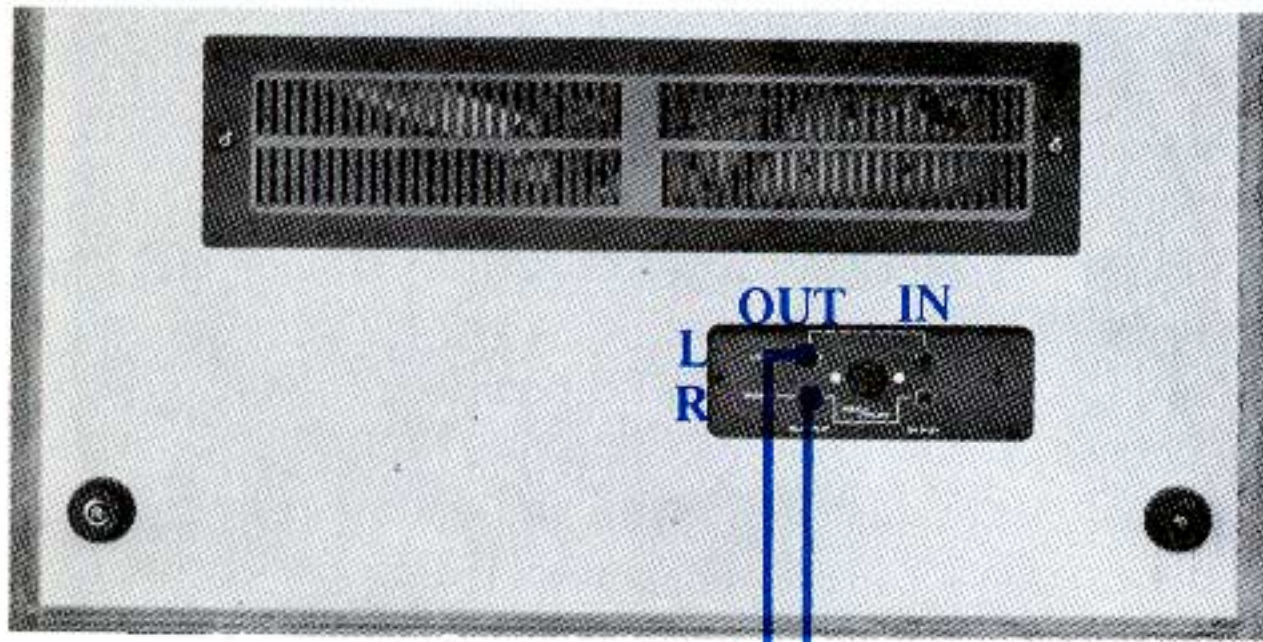

The Din Jack can be used instead of the Line Input/Output Jacks for connection with an external amplifier. This enables recording and playback with a single Din Connection Cord.

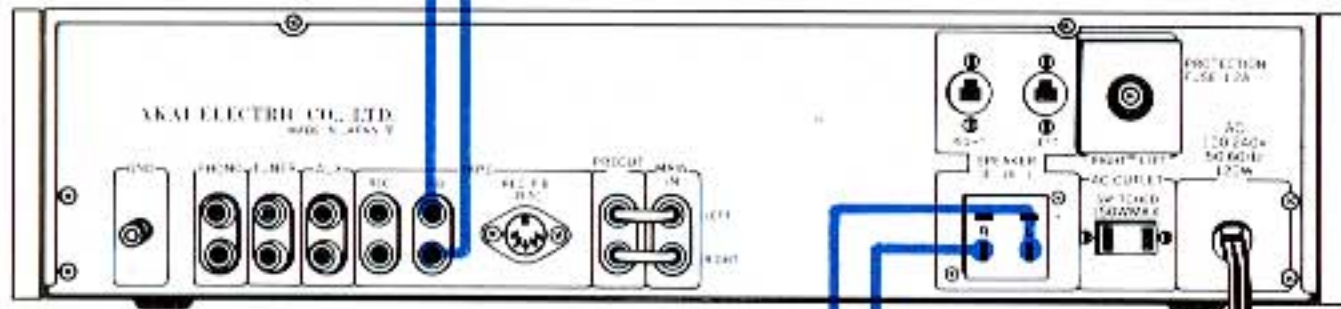

Stereo Amplifier



SPEAKER



SPEAKER



RCA/RCA
Connection Cord



DIN/DIN
Connection Cord



DIN/RCA
Connection Cord



For private headphone listening, use stereo headphones of 8 ohms impedance.

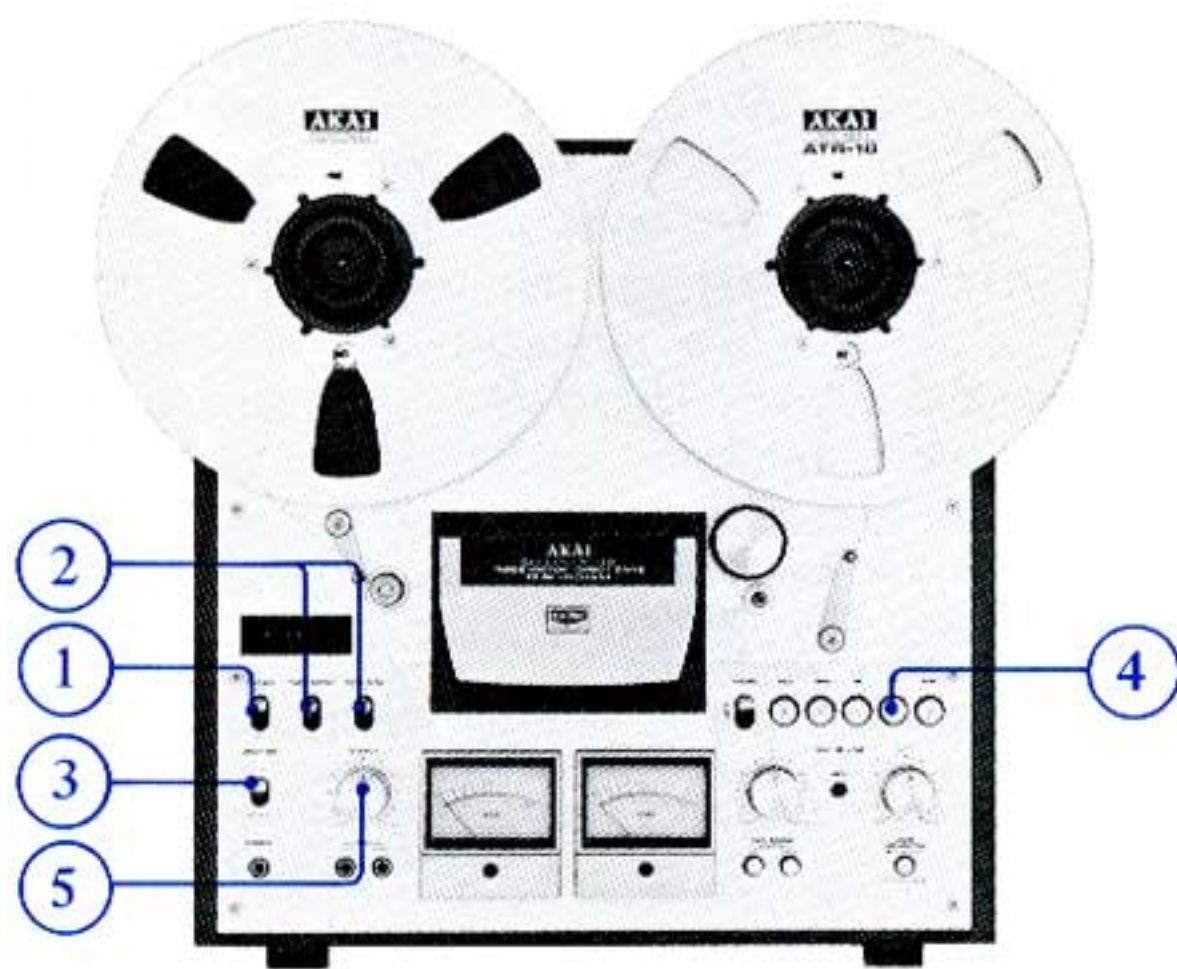

PLAYBACK

Make necessary connections as shown in CONNECTIONS FOR PLAYBACK and load a prerecorded tape.

Stereo Playback

1. Connect power cord and turn on Power Switch.
2. Set Reel Size Selector according to size of reel being used and select tape speed.
3. Set Monitor Switch to TAPE position.
4. Depress Play ► Key to begin playback.
5. Adjust Output Level Control and amplifier controls.
6. Invert reels for playback of tracks 3-2.

Monaural Playback

Monaural playback is effected in the same way as stereo. However, if monaural recordings have been made on both the left and right channels of the tape, at playback time, set the left or right output level control of the external amplifier to minimum so that only the desired channel is audible.

* Monaural headphone listening cannot be accomplished if different monaural recordings have been made on both the left and right channels of the tape (Signals from both channels are heard through headphones).

CONNECTIONS FOR RECORDING

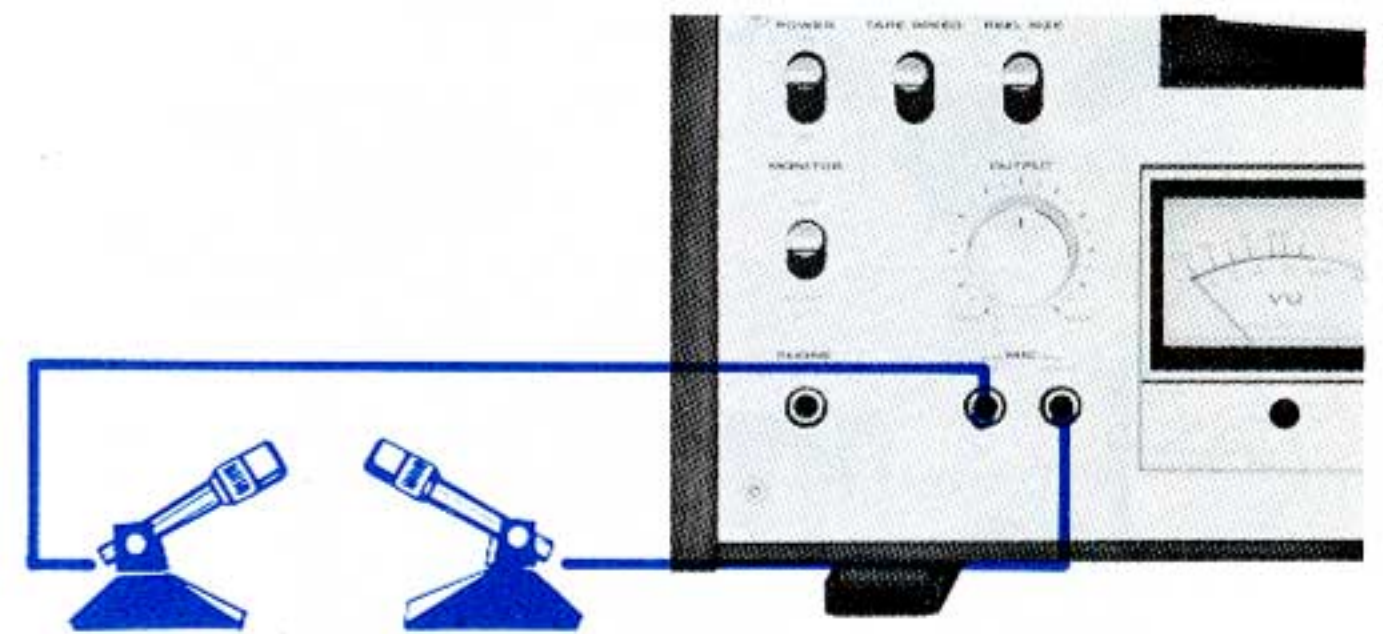
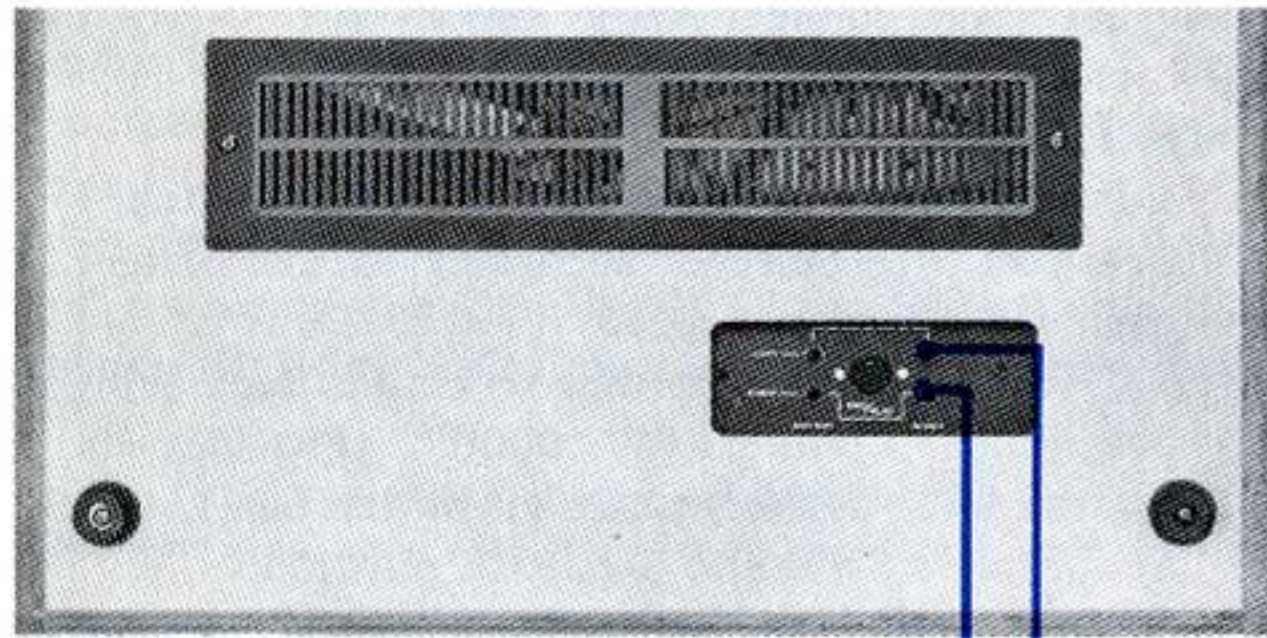

The Din Jack can be used instead of the Line Input/Output Jacks for connection with an external amplifier. This enables recording or playback with a single connection cord. In this case, the input level is adjusted with the Microphone Level Controls.

* Monitoring during recording cannot be accomplished through an amplifier system when using the Din Jack. Therefore, if monitoring during recording is desired, utilize the front panel Headphone Jack.

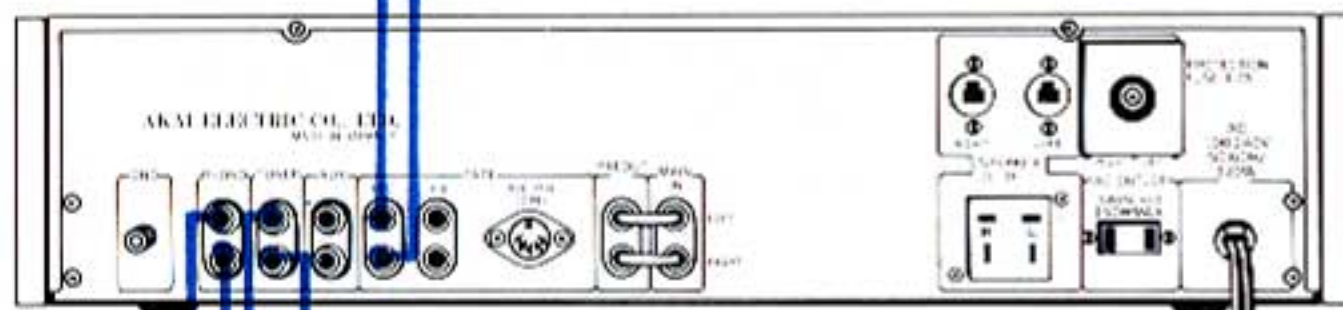

Stereo Amplifier

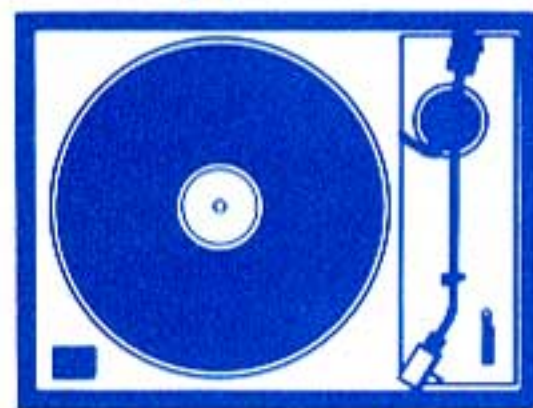

Magnetic cartridge turntable

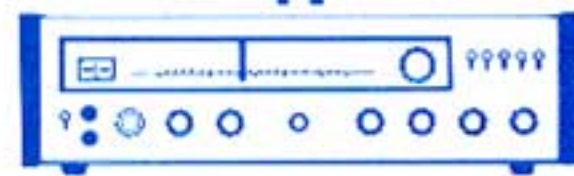

Stereo tuner



Stereo tape deck or recorder.
Do not use Din-Din connection.



Crystal or ceramic cartridge turntable

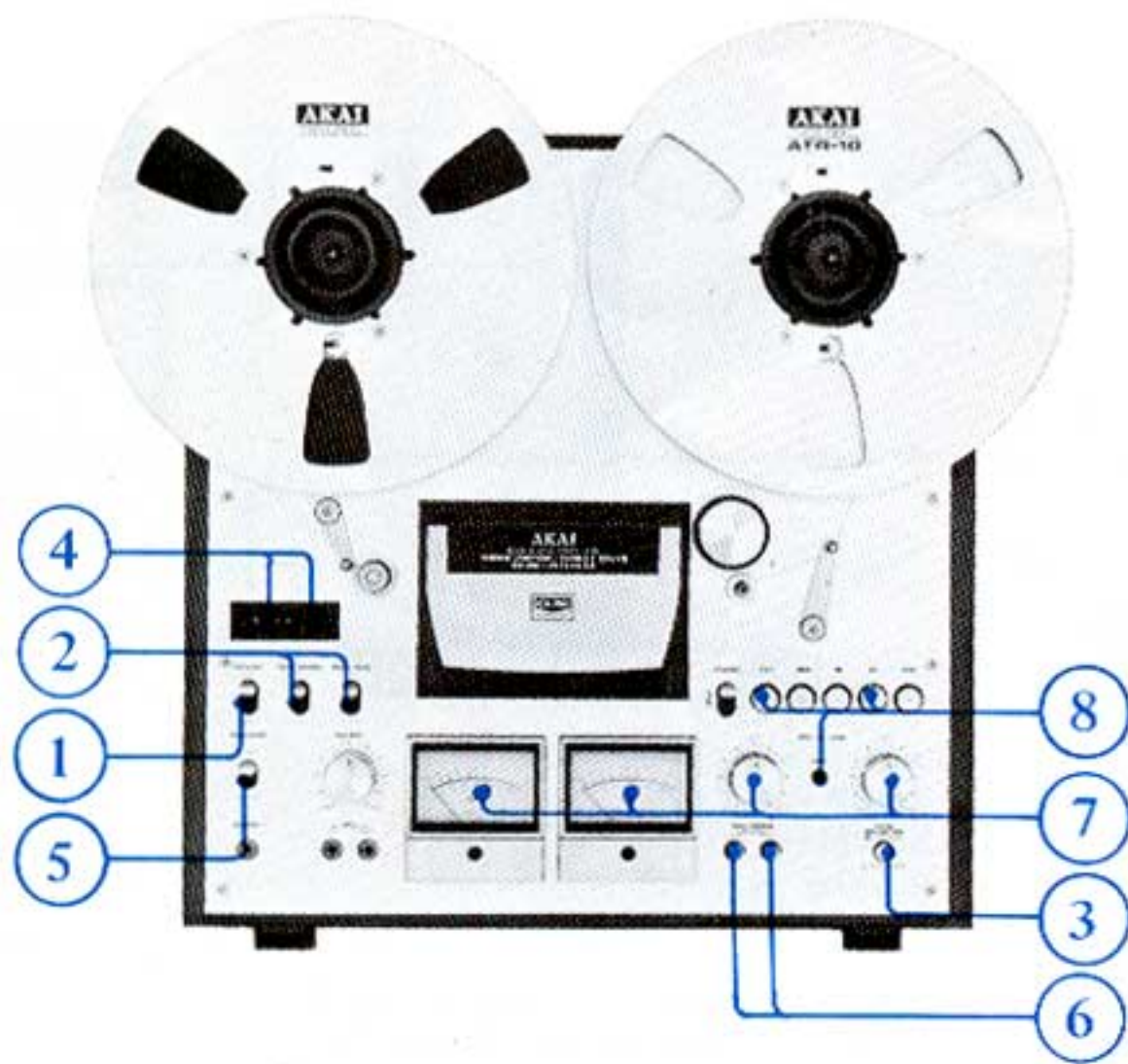

RECORDING

Make necessary connections as shown in CONNECTIONS FOR RECORDING and load a tape.

Stereo Recording

1. Connect power cord and turn on Power Switch.
2. Set Reel Size Selector according to size of reel being used and select tape speed.
3. Set Tape Selector according to kind of tape being used.
4. Set Index Counter to "0000". (Provides an easy reference for locating positions on the tape).
5. Set Monitor Switch to SOURCE position.
6. Depress Left and Right Recording (Track Selector) Switches.
7. Adjust and balance input level with corresponding Recording Level Controls while observing the VU Meters. (Normal recording should not exceed 0 VU on either meter).
8. When an optimum recording level has been determined, while holding the Recording (REC) Button at depressed position, depress Play ► Key to begin recording. (The Recording Indicator Lamp will light to indicate recording mode).
9. Invert reels for recording on tracks 3-2.

Monaural Recording

For monaural recording, substitute the following steps for steps 6, 7, 8 and 9 of Stereo Recording procedure.

Tracks 1 and 4

Only the left channel is used for monaural recording on tracks 1 and 4.

6. Depress Left Recording (Track Selector) Switch.
7. Adjust and balance input level with corresponding left Recording Level Control while observing the left VU Meter. (Normal recording should not exceed 0 VU).
8. When an optimum recording level has been determined, while holding the Recording (REC) Button at depressed position, depress Play ► Key to begin recording. (The Recording Indicator Lamp will light to indicate recording mode).
9. Invert reels for recording on track 4.

Tracks 3 and 2

Only the right channel is used for monaural recording on tracks 3 and 2.

6. Depress Right Recording (Track Selector) Switch.
7. Adjust and balance input level with corresponding right Recording Level Control while observing the right VU Meter. (Normal recording should not exceed 0 VU).
8. When an optimum recording level has been determined, while holding the Recording (REC) Button at depressed position, depress Play ► Key to begin recording. (The Recording Indicator Lamp will light to indicate recording mode).
9. Invert reels for recording on track 2.

SOUND MIXING

Independent line and microphone recording level controls and input jacks enable signals from microphones and from line sources to be blended and recorded simultaneously on the tape.

Connect microphones to Microphone Jacks and connect desired source to the Line Input Jacks. Follow recording procedure, adjusting both Line and Microphone Input Level Controls.

* Line and Din mixing can also be accomplished. In this case, Din input level is adjusted with Microphone Input Level Controls.

ABSENTEE RECORDING

By using an external timer together with Akai Remote Control Unit RC-17, absentee recording can be accomplished with this machine. Connect Remote Control Unit to Remote Control Jack and properly load a tape, avoiding tape slack. Plug in AC Cord through the external timer. Adjust input level following recording procedure and with the Power Switch turned ON and the Remote Control Unit REC and FWD Play Keys locked into recording mode positions, set timer, following manufacturers instructions. If timer is set to coincide with source timing, the GX-630 D will automatically begin recording according to setting.

* This machine features Automatic Stop which is effected at the end of the tape.

TAPE ERASING

Any signals previously recorded on the tape will be automatically erased as a new recording is made. For erasing only, thread the tape and set machine to recording mode. No plugs should be connected to the input jacks and the input level controls should be kept at minimum. For quick and complete erasure, a bulk tape eraser is recommended.

* Be sure to depress the proper Recording (Track Selector Switch(es)). If both switches are depressed, both the left and right channels will be erased.

TAPE SPLICING AND EDITING

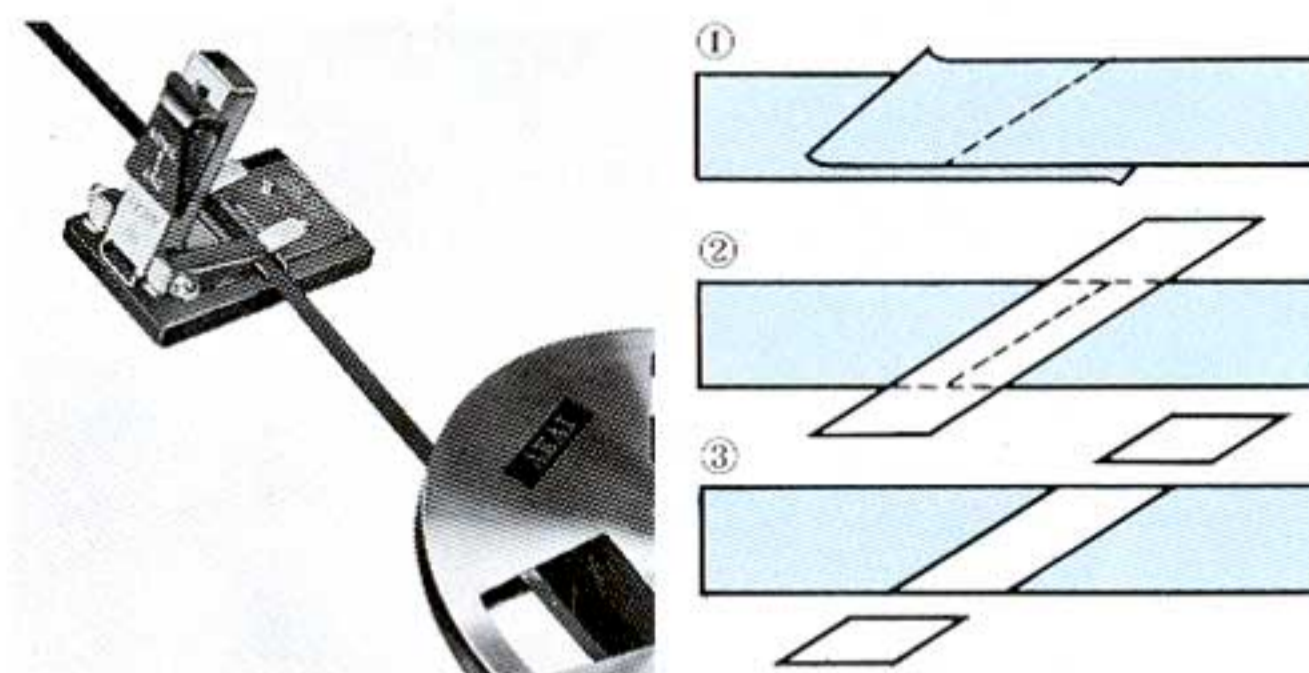

Cut the tape diagonally with an overlap so that the ends are lined up. Cutting tape on the diagonal eliminates detection of the splice in recording. Cover aligned ends with splicing tape, exerting pressure to secure ends evenly. Trim off excess splicing tape. Cutting into magnetic tape very slightly will eliminate the possibility of a sticky splice. Splicing using scissors requires skillful work.

For smooth and easy splicing, Akai Tape Splicer AS-3 is highly recommended.

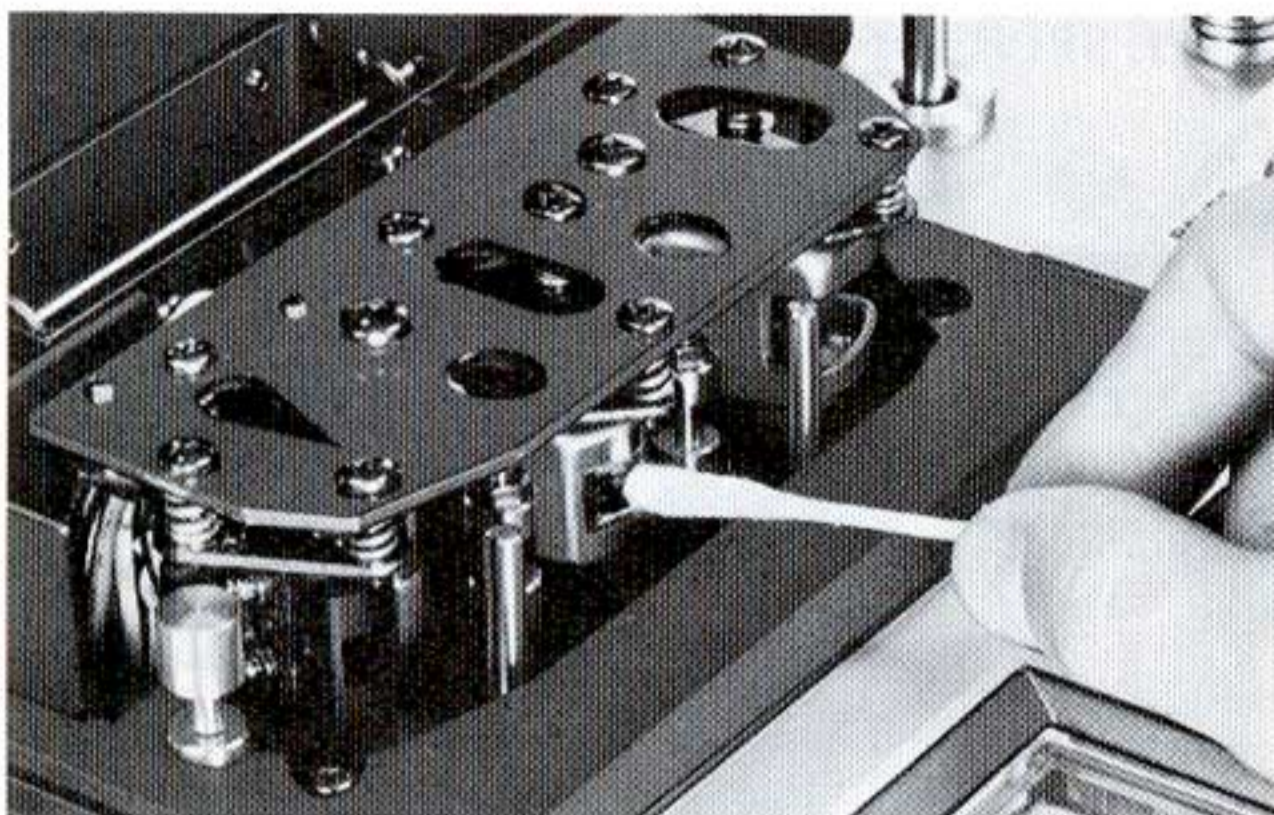

HEAD BLOCK CLEANING

Heads

The GX (glass and crystal) Heads do not require a great deal of cleaning. However, if old tapes or tapes which have been spliced are used, GX head cleaning is also recommended.

Clean recording, playback, and erase heads with a cotton swab stick which has been dipped in Akai Cleaning fluid from Head Cleaning Kit HC-500.

Pinch wheel and capstan

If foreign matter is allowed to accumulate on the pinch wheel and capstan, these particles will come off on the tape causing deterioration of sound quality. Oil adhering to the capstan also causes irregularity in tape transport. Therefore, it is also recommended that these parts be wiped clean periodically. Use Akai cleaning fluid or alcohol.

- * Do not use chemicals such as chloroethane, etc. for head block cleaning as the rubber parts will deteriorate.

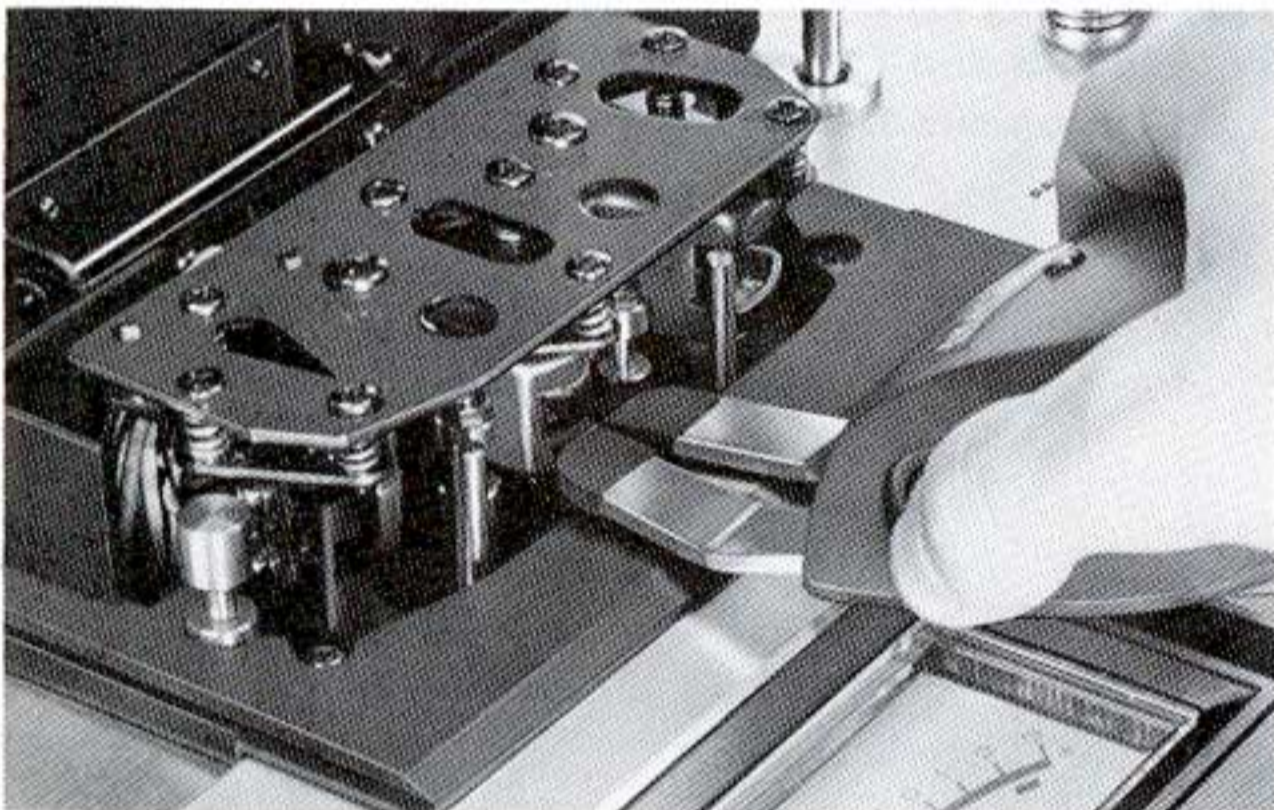

HEAD DEMAGNETIZING

Prolonged use of the machine will gradually build up residual magnetism on the heads. The effect of magnetization is that it causes a considerable drop in high frequency response and introduces noise into your recordings. It is therefore, recommended that head demagnetizing be performed periodically. This can be accomplished with a bulk head demagnetizer by bringing the prongs of the demagnetizer close to the heads and making several small circular motions over all head surface areas as well as the head housing.

- * Turn off the power of the unit prior to demagnetizing the heads.
- * Do not use magnetized tools in the vicinity of the heads and VU Meters.
- * Do not bring the magnetizer close to the VU Meters.

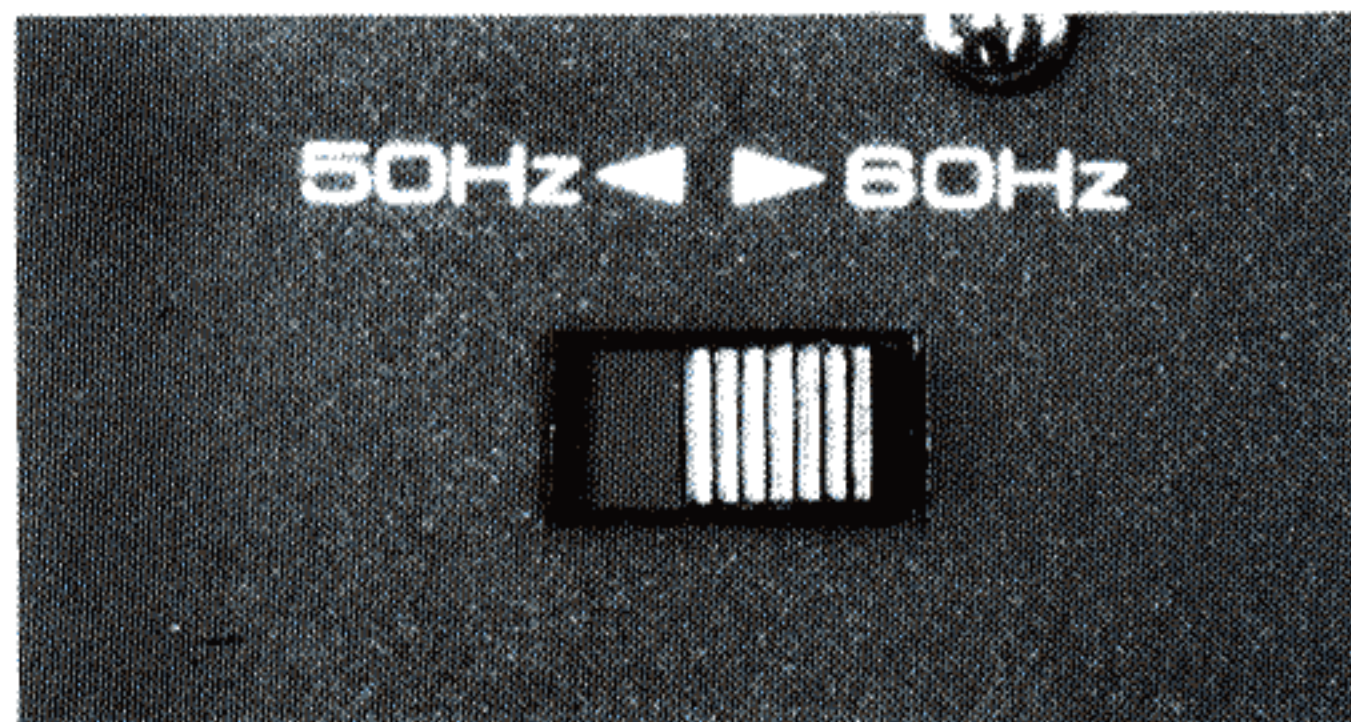
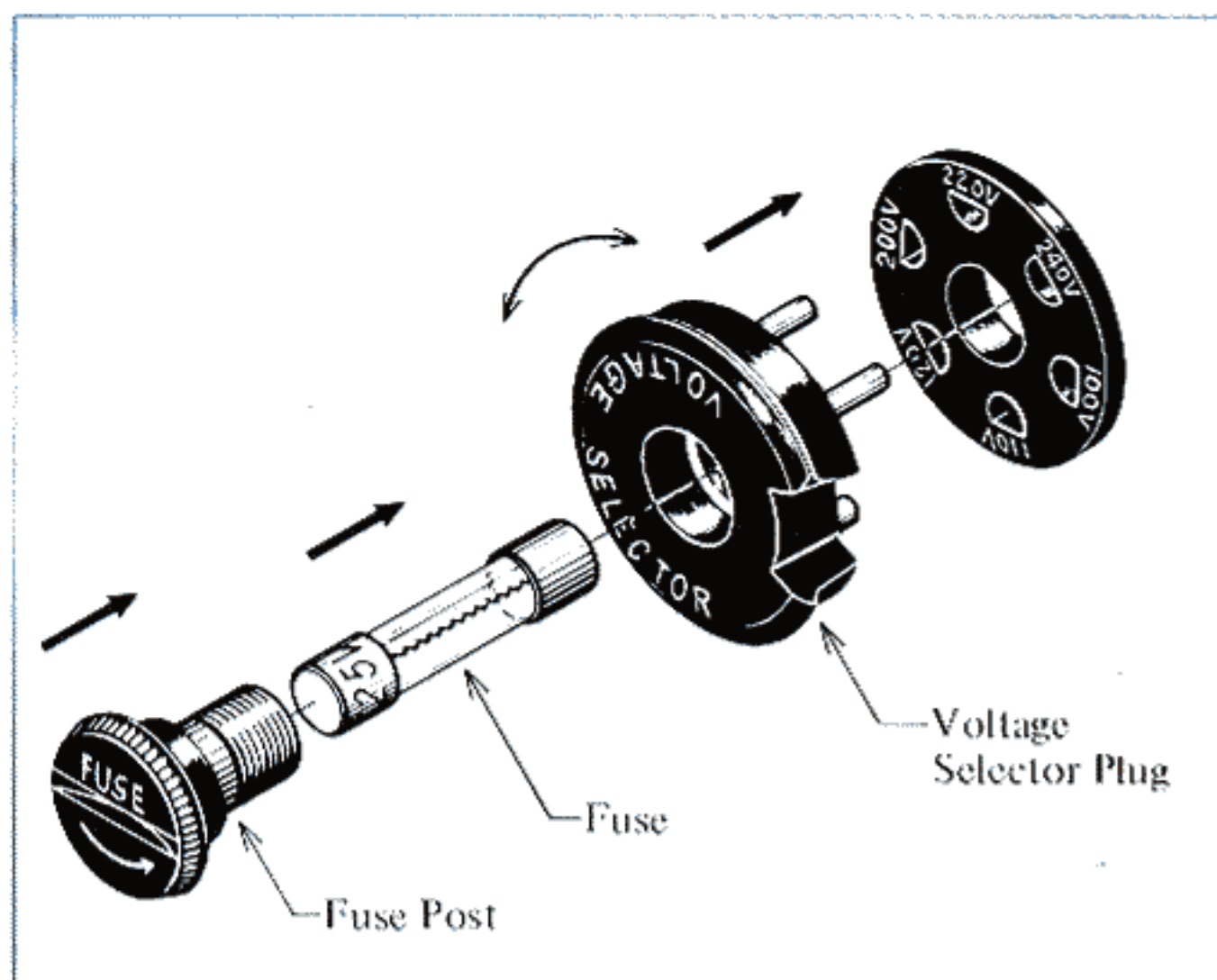

VOLTAGE AND CYCLE CONVERSION (CEE, CSA, UL and LA models are not equipped with voltage and cycle change apparatus).

VOLTAGE

Your machine is equipped with a universal voltage selector offering a selection of voltage from 100V to 240V A.C. Voltage is preset at the factory according to destination. However, the operator is requested to reconfirm setting and, if necessary, readjust as follows:

1. DISCONNECT POWER CORD and remove the Fuse Post by screwing in direction of arrow.
2. Remove the Voltage Selector Plug and reinsert so that proper area voltage shows through the plug cut-out.
3. Change fuse to correspond with voltage and tighten fuse post. (Refer to standard accessory spare fuse tag instructions for proper fuse).

To maintain optimum performance and prolong the life of your machine, it is important that the line voltage be held within 10% of standard area voltage.

CYCLE

Correct tape speed cannot be obtained if the Cycle Change Switch located on the rear panel is not properly set. Set to 50 Hz or 60 Hz position according to area power source.

STANDARD ACCESSORIES

Connection Cord (RR-163)	1 set
10-1/2" Reel Hub Adapters	1 set
Empty Reel (R-10M)	1
Spare fuses	1 set
Operator's Manual	1

* Spare fuses not included with CEE, CSA, UL and LA models.

TECHNICAL DATA

Track System	4 track 2 channel stereo/monaural system
Reel Capacity	Up to 10-1/2" reel
Tape Speed	7-1/2 and 3-3/4 ips ($\pm 0.7\%$)
Wow and Flutter	Less than 0.06% RMS at 7-1/2 ips Less than 0.09% RMS at 3-3/4 ips
Frequency Response	30 Hz to 25,000 Hz (± 3 dB) at 7-1/2 ips using Akai LN-150-7 tape. 30 Hz to 19,000 Hz. (± 3 dB) at 3-3/4 ips using Akai LN-150-7 tape.
Distortion	Less than 0.5% (1,000 Hz "0" VU) at 7-1/2 ips
Signal-to-Noise Ratio	Better than 57 dB (measured via tape with peak recording level of + 6 VU)
Erase Ratio	Better than 70 dB
Bias Frequency	100 kHz
Heads	(3): One GX playback, one GX recording, and one erase head
Motors	(3): One AC servo motor for capstan drive, two eddy current motors for reel drive.
Fast Forward and Rewind Time	120 seconds using a 2,400 ft. tape
Output Jacks	Line (2): 0.775V (0 VU) Phone (1): 30 mV/8 ohms
Input Jacks	Microphone (2): 0.25mV Line (2): 70mV
Din Jack	0.5V/2.5mV
Semi Conductors	Transistors 50, Diodes 57
Power Requirements	USA and CANADA Models: 120V, 60 Hz only CEE Models: 220V, 50 Hz only Other Models: 100V to 240V, 50/60 Hz (Switchable)
Power Consumption	100 W (CEE), 90W (CSA)
Dimensions	465(H) x 440(W) x 240(D)mm (18.3 x 17.4 x 9.4")
Weight	19 kg (41.8 lbs)

* For improvement purposes, specifications and design are subject to change without notice.

TROUBLE SHOOTING CHART

The conditions listed below do not indicate mechanical failure of your unit. If your machine exhibits any of these conditions, check for trouble as indicated.

SYMPTOM	TROUBLE	REMEDY
Loss of sensitivity and tone quality.	<ul style="list-style-type: none"> * Dirty Erase Head. * Wrong side of tape facing the heads. * A.C. power lower than the voltage to which your machine is adjusted. * Magnetized head. * Tape Selector Switch is set incorrectly. 	<ul style="list-style-type: none"> * See HEAD BLOCK CLEANING. * See VOLTAGE & CYCLE CONVERSION. * See HEAD DEMAGNETIZING.
Machine will not record or playback.	<ul style="list-style-type: none"> * Check positions of controls and input/output. * Check position of the Recording (Track Selector) Switches. * Check position of the Automatic Stop/Tape Tension lever. * Output Level Control at minimum. 	
Irregularity in tape transport.	<ul style="list-style-type: none"> * Oil or magnetic particles adhering to the Capstan or Pinch Wheel. * Sticky or dirty tape surface. * Improperly loaded tape. * A.C. power lower than the voltage to which your machine is adjusted. 	<ul style="list-style-type: none"> * See HEAD BLOCK CLEANING. * See TAPE LOADING. * See VOLTAGE & CYCLE CONVERSION.
Tape will not run.	<ul style="list-style-type: none"> * Blown fuse. * Power is not being supplied. * Twisted or sticky tape. 	<ul style="list-style-type: none"> * Check power cord, Power Switch, and Automatic Stop/Tape Tension Lever.
Previously recorded program will not erase.	<ul style="list-style-type: none"> * Erase head is dirty. 	<ul style="list-style-type: none"> * See HEAD BLOCK CLEANING.
Distorted or noisy sound.	<ul style="list-style-type: none"> * Recording level is too high. * Check external source controls and connections. 	<ul style="list-style-type: none"> * Normal recording level is zero VU.



MANUFACTURED & DISTRIBUTED BY
AKAI ELECTRIC CO., LTD.
AKAI TRADING CO., LTD.

12-14, 2-chome, Higashi-Kojiya,
Ohta-ku, Tokyo, Japan

AKAI AMERICA, LTD.

2139 E. Del Amo Blvd., Compton, Calif., 90220, U.S.A.
TELEPHONE: (213) 537-3880
TELEX: 67-7494



Printed in Japan